

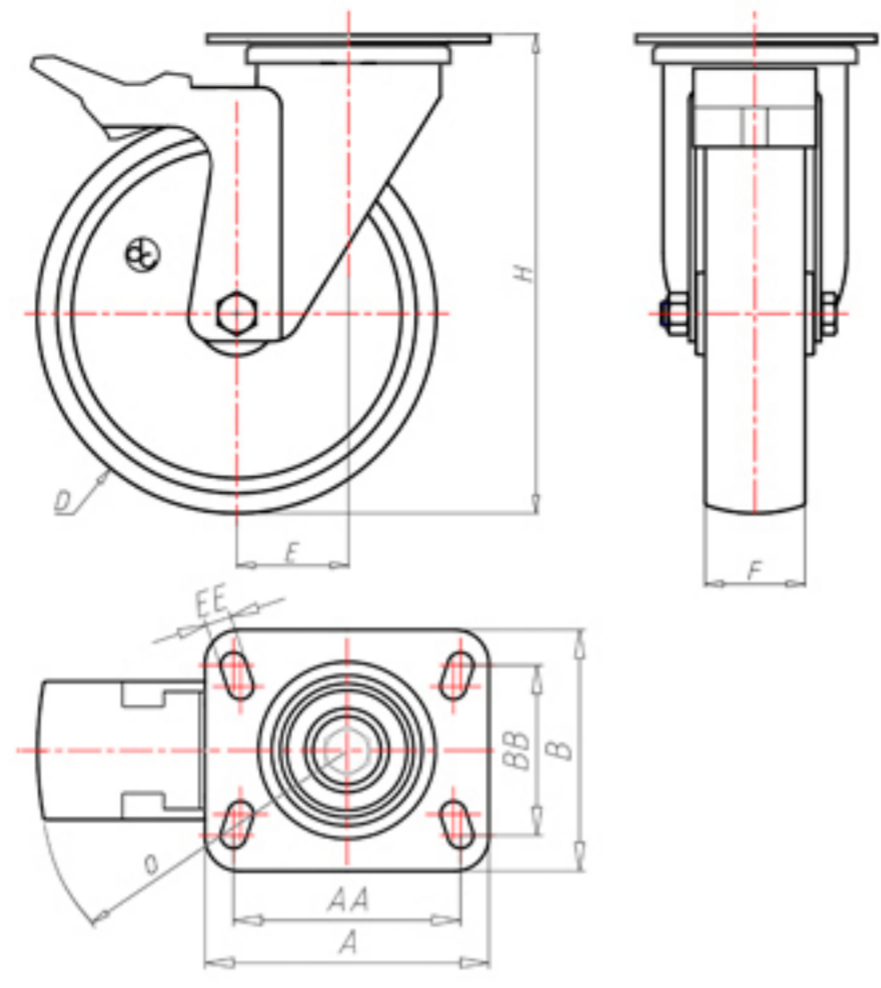









72 Shore A
 +80°C
 -40°C



	D	125
	F	35
	H	158
	AxB	100x85
	AAxBB	80x60
	EE	9
	E	44
	O	124
	LC	210



Code for plain bore wheel

XSGZ12545PFA

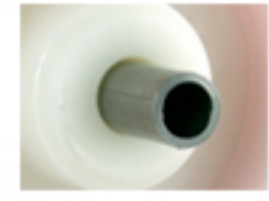

Code for wheel with roller bearing

XSGZ12545PRFA

