

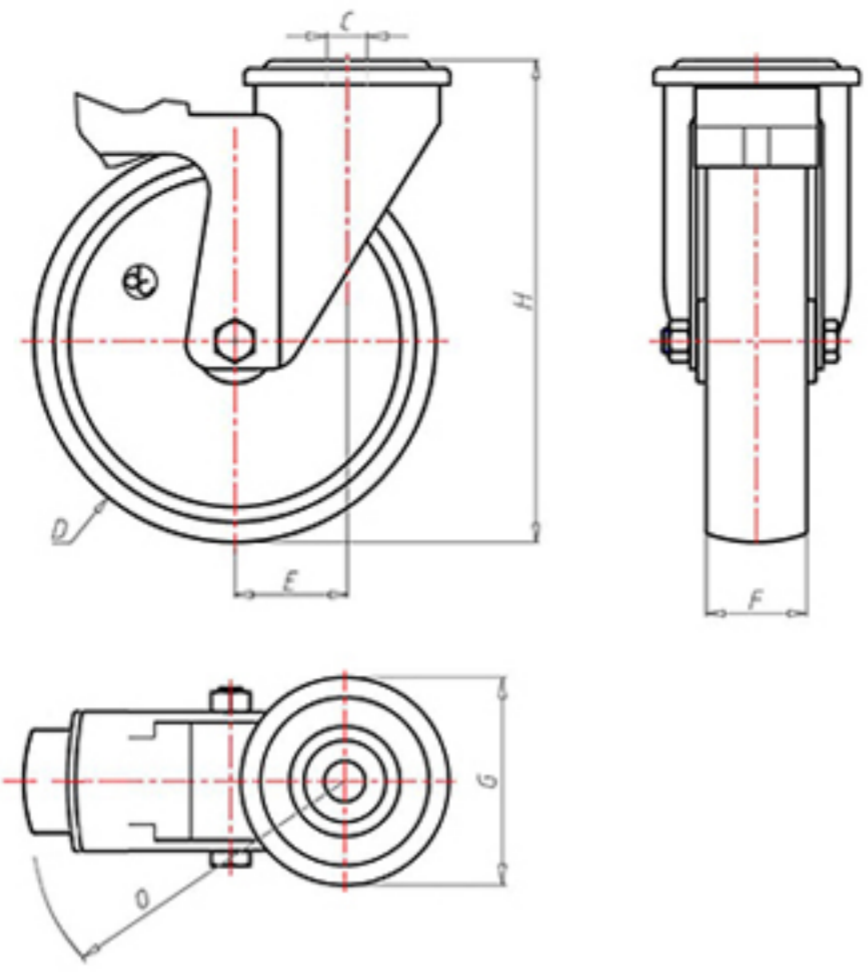







72 Shore A  
 +80°C  
 -40°C



	D	100
	F	33
	H	128
	G	Ø 77
	C	Ø 12
	E	42
	O	104
	Kg weight	LC
		180



Code for plain bore wheel

**XSPZ10045FS**

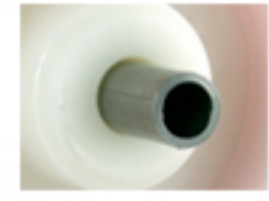

Code for wheel with roller bearing

**XSPZ10045RFS**

