

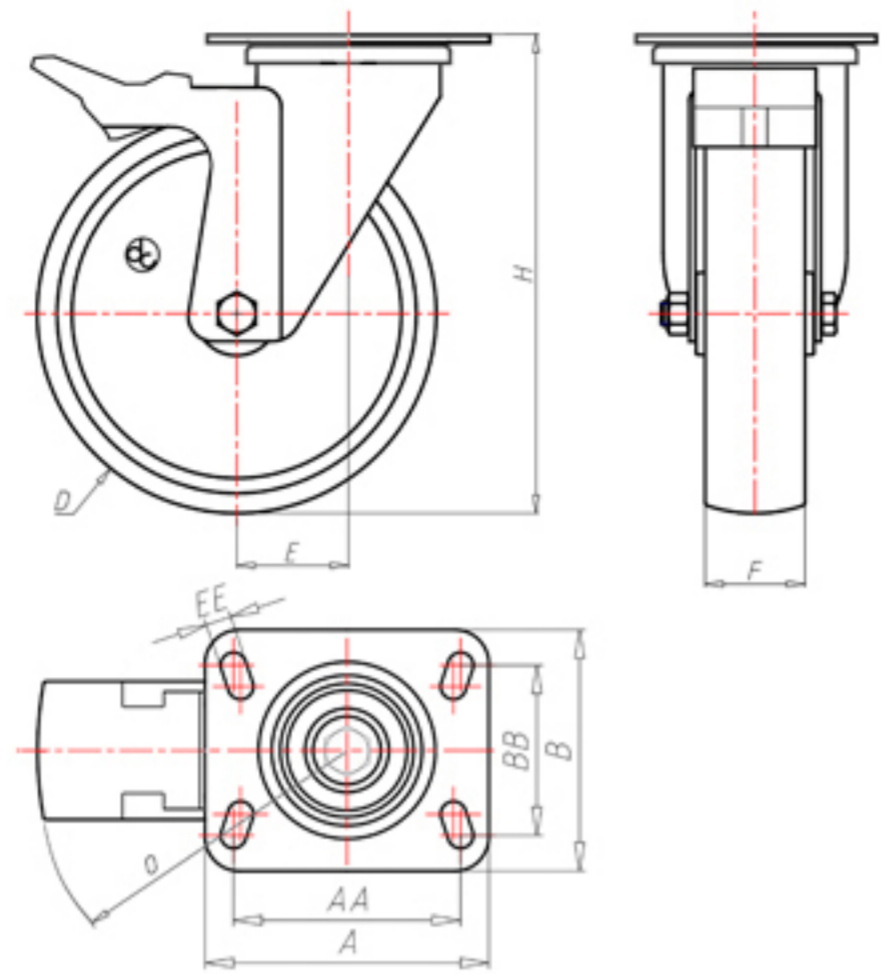

70 Shore D  
+90°C  
-40°C



	D	100
	F	33
	H	131
	AxB	100x85
	AAxBB	80x60
	EE	9
	E	42
	O	124
	LC	250



Code for plain bore wheel  
**NYGX10040PFA**

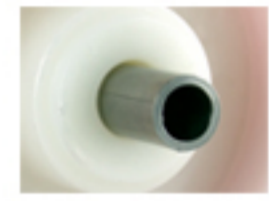

Code for wheel with roller bearing  
-



Code for wheel with Inox roller bearing  
**NYGX10040PRXFA**

