

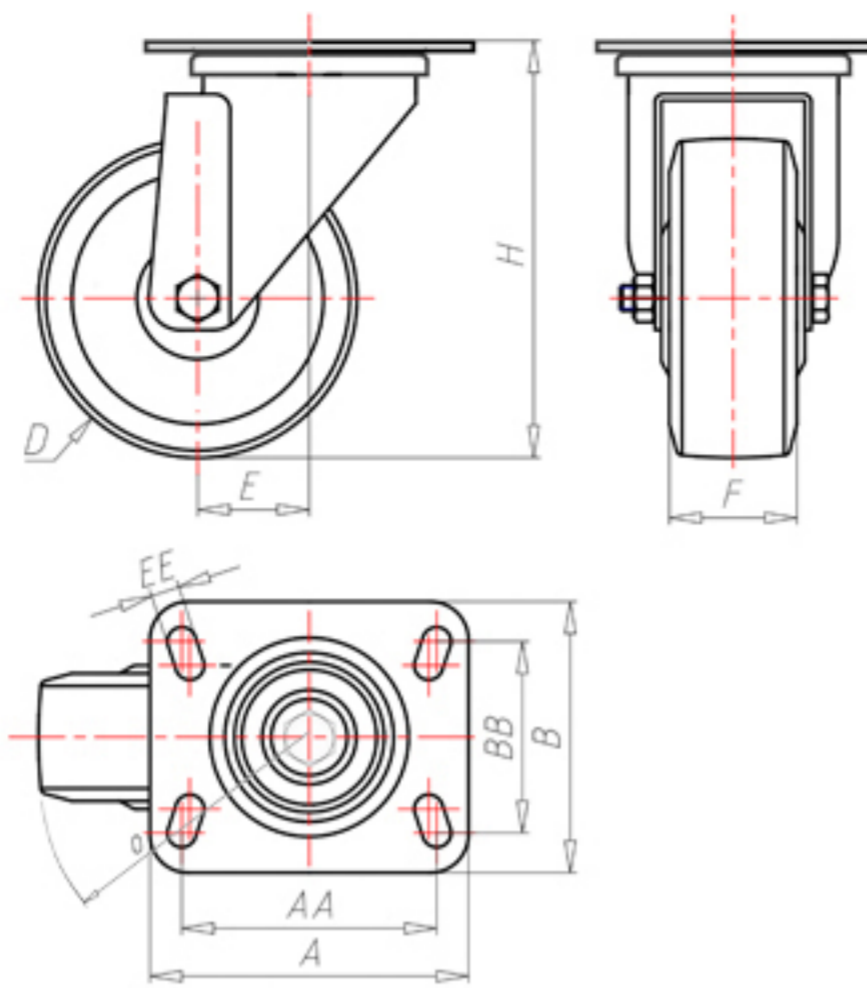

70 Shore D
+90°C
-40°C



	D	100
	F	33
	H	131
	AxB	100x85
	AAxBB	80x60
	EE	9
	E	42
	O	92
	LC	250



Code for plain bore wheel
NYGX10045P

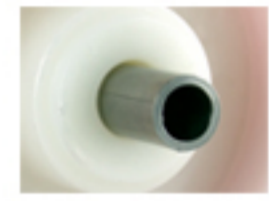

Code for wheel with roller bearing
-



Code for wheel with Inox roller bearing
NYGX10045PRX

