

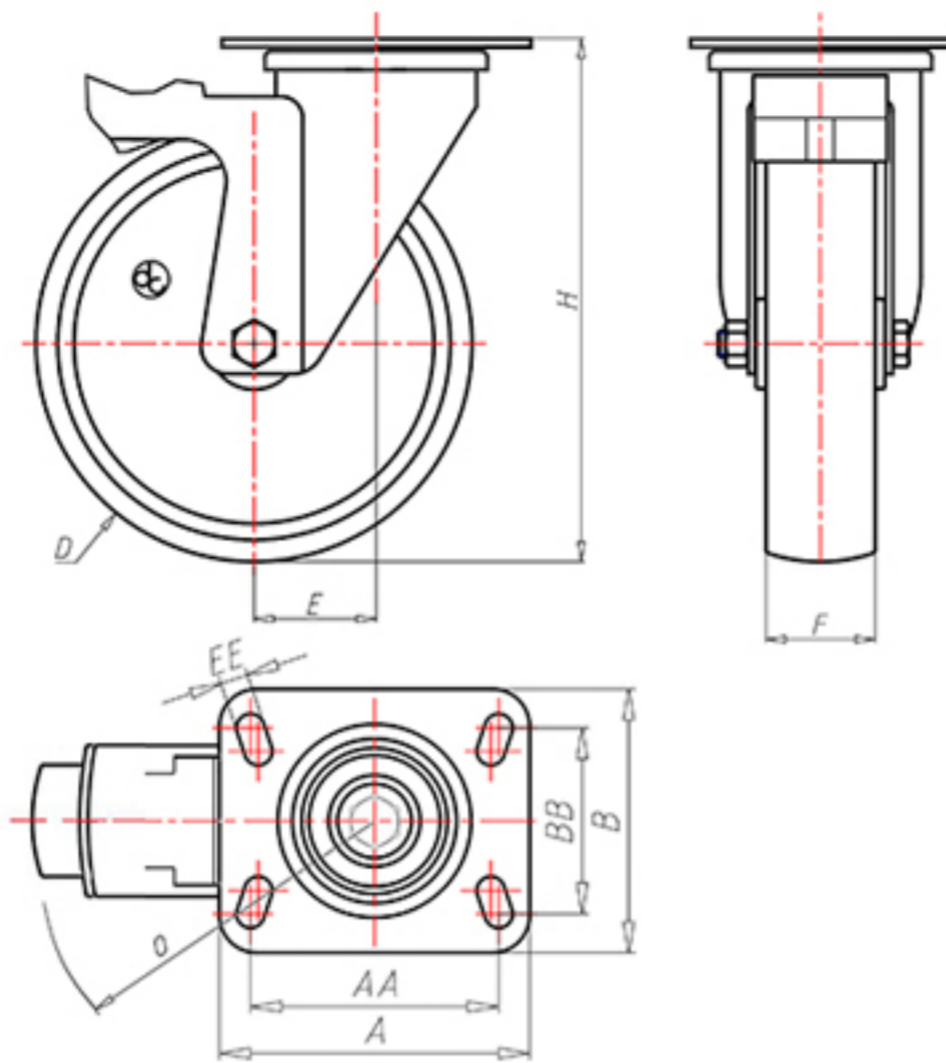

70 Shore D
+90°C
-40°C



	D	125
	F	35
	H	158
	AxB	100x85
	AAxBB	80x60
	EE	9
	E	44
	O	124
	LC	260



Code for plain bore wheel

NYGX12545PFS



Code for wheel with roller bearing

-



Code for wheel with Inox roller bearing

NYGX12545PRXFS

