

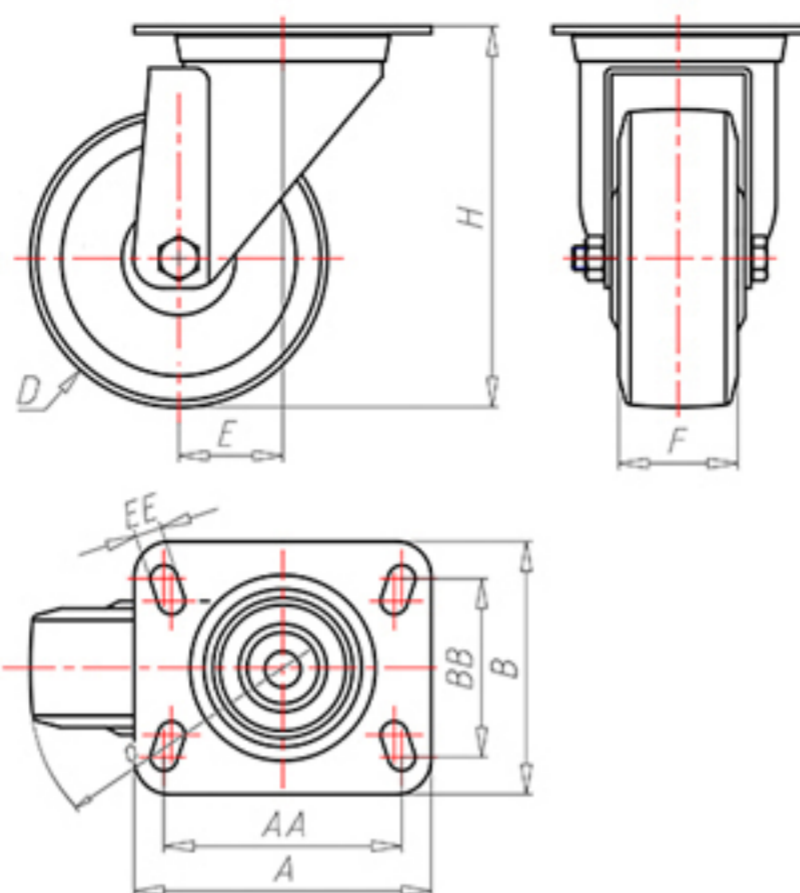

70 Shore D
+90°C
-40°C



	D	200
	F	50
	H	232
	AxB	135x110
	AAxBB	105x80
	EE	11
	E	56
	O	167
	LC	400



Code for plain bore wheel

NYGX20060



Code for wheel with roller bearing

-



Code for wheel with Inox roller bearing

NYGX20060RX

