

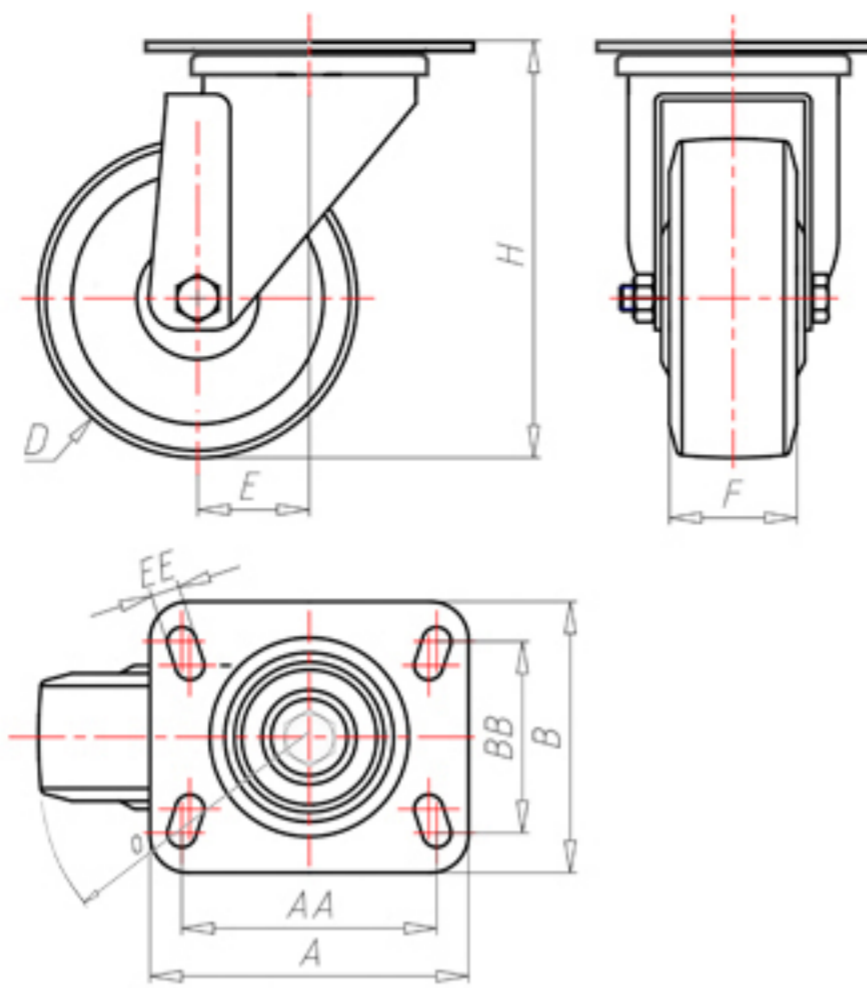

70 Shore D
+90°C
-40°C



	D	80
	F	33
	H	110
	AxB	100x85
	AAxBB	80x60
	EE	9
	E	40
	O	82
	LC	210



Code for plain bore wheel
NYGX8045P

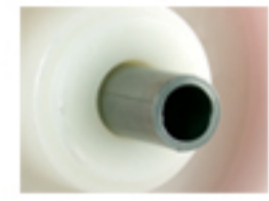

Code for wheel with roller bearing
-



Code for wheel with Inox roller bearing
NYGX8045PRX

