

D-NAMIC

92 Shore A  
+90°C  
-40°C

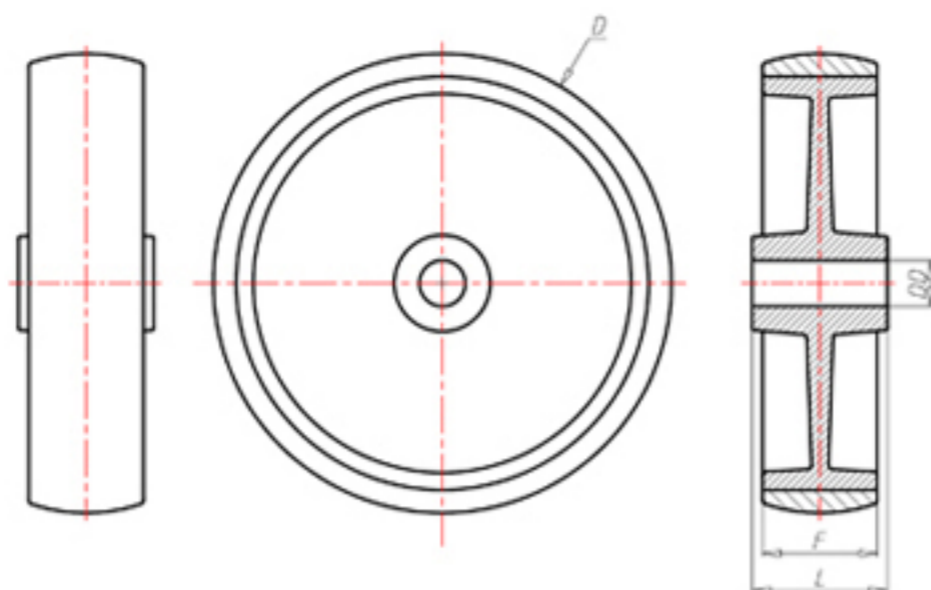

	D	150
	F	40
	L	40
	DD	Ø 15
	LC	380



Code for plain bore wheel

-



Code for wheel with roller bearing

-



Code for wheel with Inox roller bearing

-



Code for wheel with double sealed ball bearing

PXN15040C



Code for wheel with double sealed Inox ball bearing

PXN15040CX

