

**DITHERM
RHT**

+260°C
-40°C

INOX

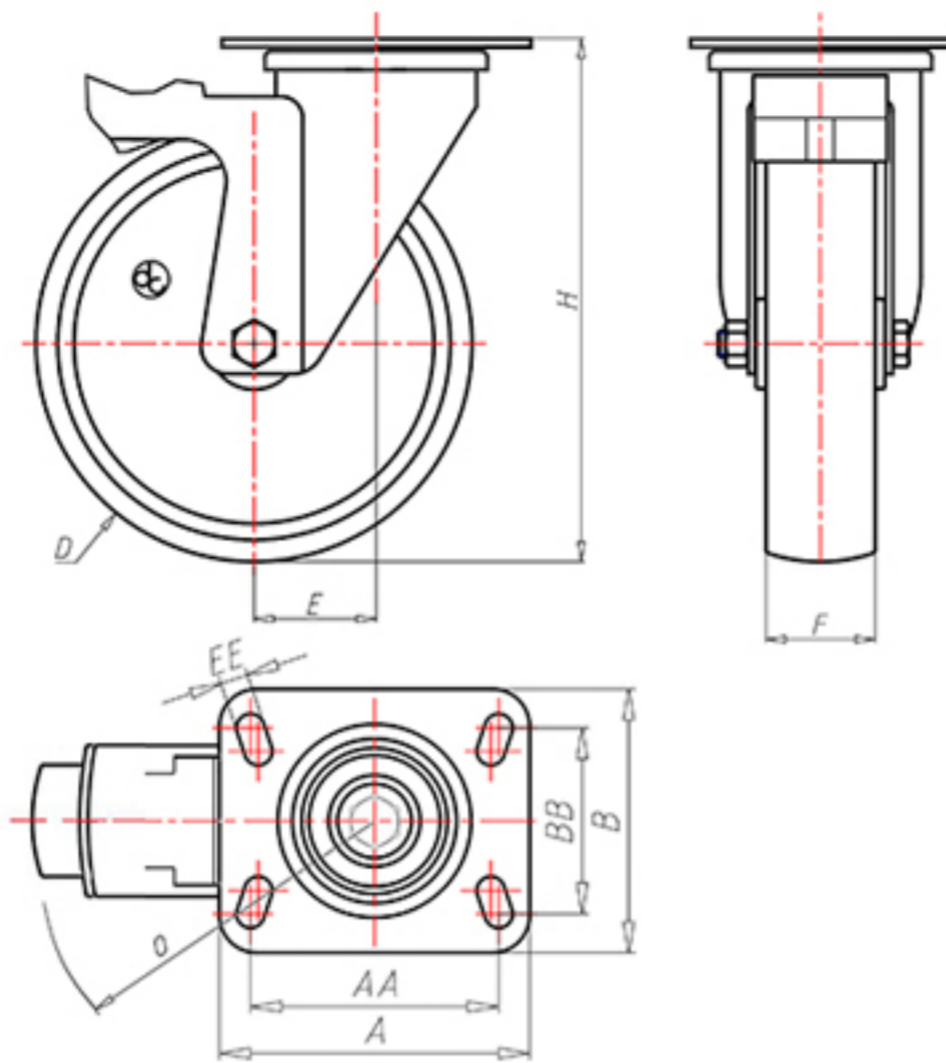

	D	80
	F	30
	H	110
	AxB	100x85
	AAxBB	80x60
	EE	9
	E	40
	O	124
	LC	100



Code for plain bore wheel

RGX80PFS



Code for wheel with coated bush

RGX80PBRFS



Code for wheel with double BT self-lube bush

RGX80PBTFS



Code for wheel with double HT ball bearing

RGX80PCFS

