

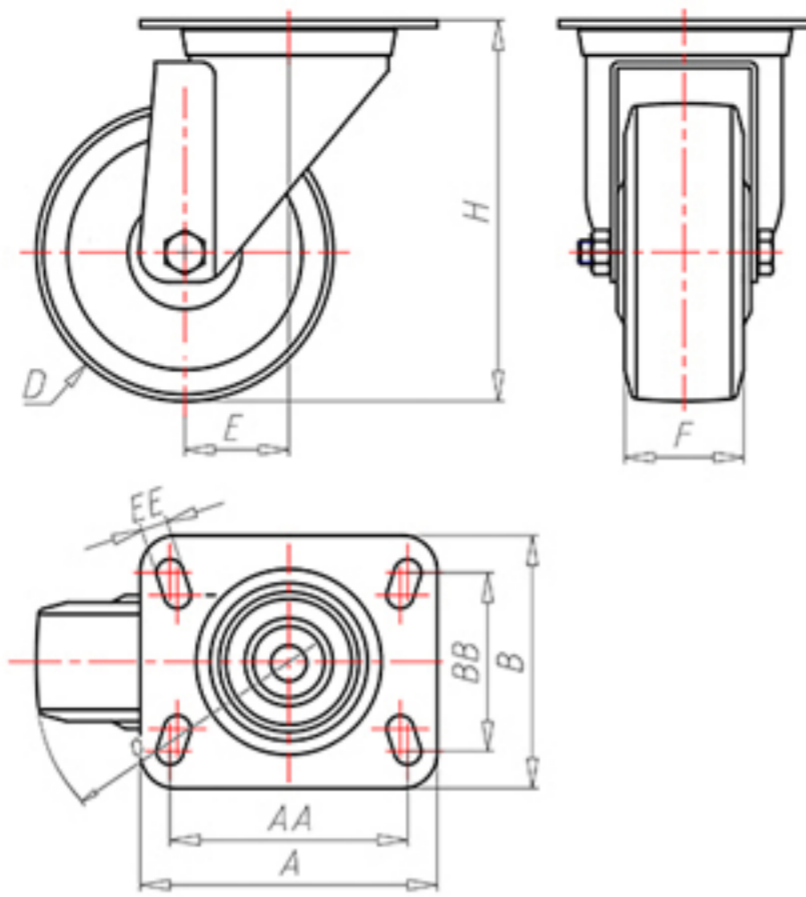

+260°C
-40°C



	D	80
	F	30
	H	108
	AxB	100x85
	AAxBB	80x60
	EE	9
	E	40
	O	82
	LC	100



Code for plain bore wheel

RGZ80



Code for wheel with coated bush

RGZ80BR



Code for wheel with double BT self-lube bush

RGZ80BT



Code for wheel with double HT ball bearing

RGZ80C

