

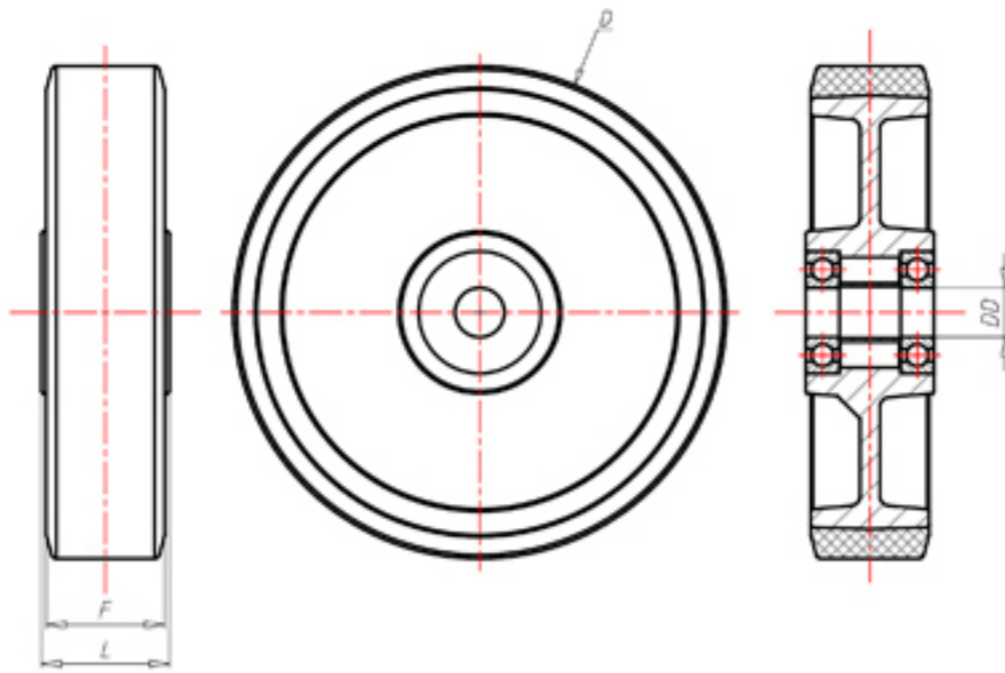

+260°C
-40°C



	D	80
	F	30
	L	40
	DD	Ø 8
	LC	100



Code for plain bore wheel

-



Code for wheel with coated bush

RHT100BR



Code for wheel with double BT self-lube bush

-



Code for wheel with double HT ball bearing

-

