

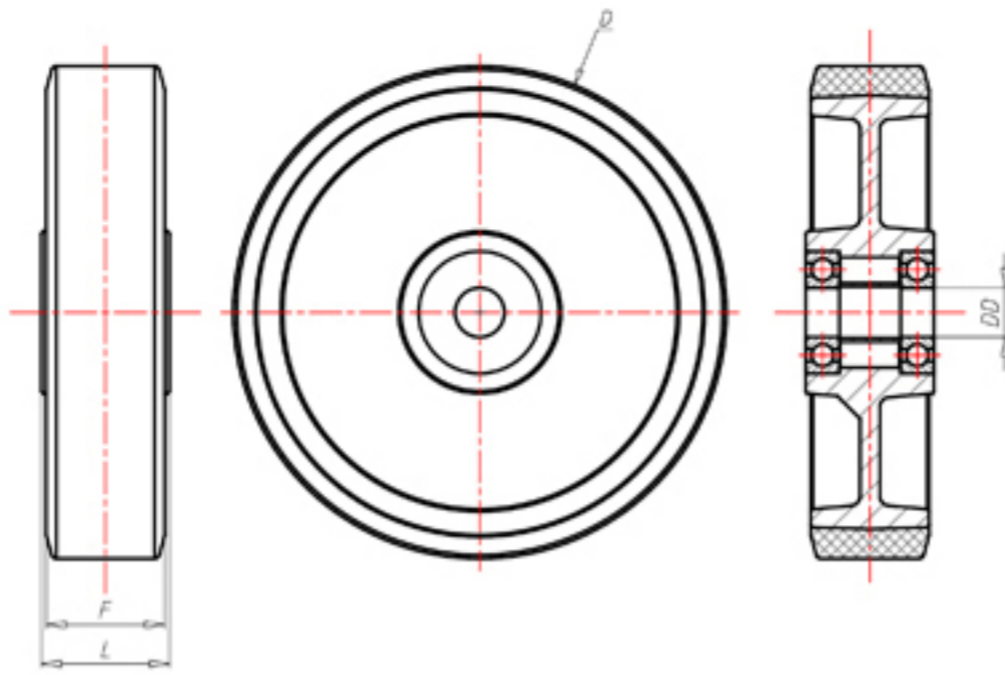

+260°C
-40°C



	D	80
	F	30
	L	45
	DD	Ø 10
	LC	100



Code for plain bore wheel

-



Code for wheel with coated bush

-



Code for wheel with double BT self-lube bush

RHT80BT



Code for wheel with double HT ball bearing

-

