

**DITHERM
RHT**

+260°C
-40°C

INOX

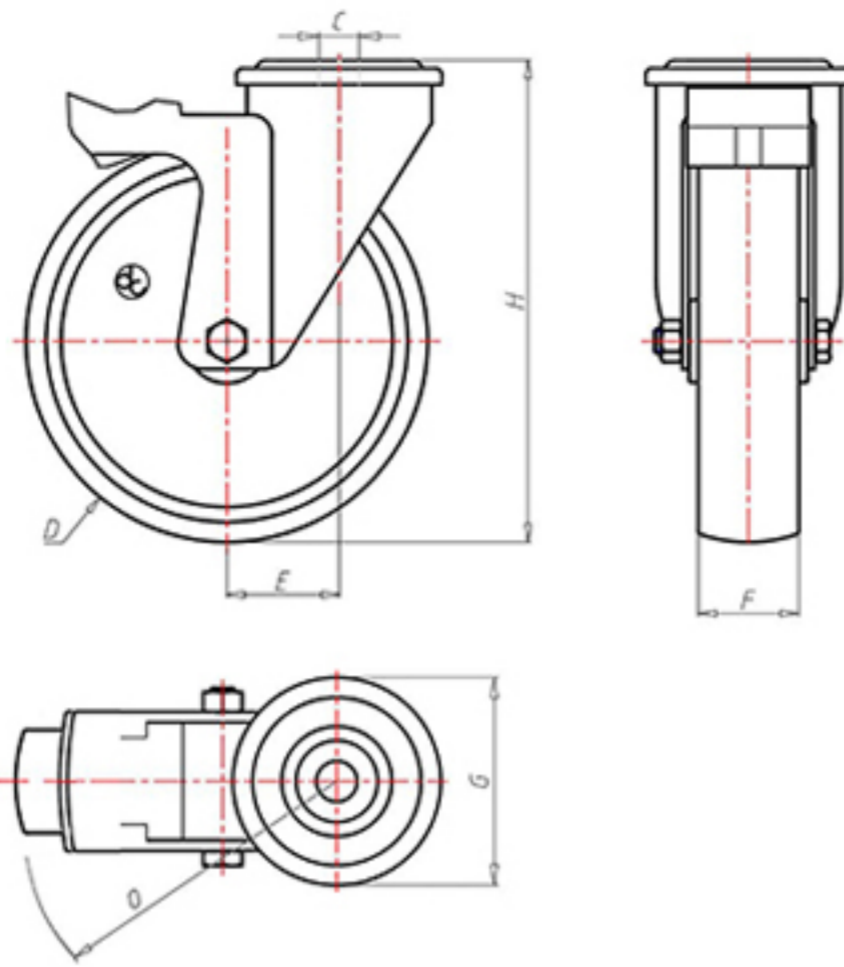

	D	80
	F	30
	H	108
	G	Ø 77
	C	Ø 12
	E	40
	O	124
	LC	100



Code for plain bore wheel

RPX80FS



Code for wheel with coated bush

RPX80BRFS



Code for wheel with double BT self-lube bush

RPX80BTFS



Code for wheel with double HT ball bearing

RPX80CFS

