

**DITHERM
MTW**

+280°C
-70°C

INOX

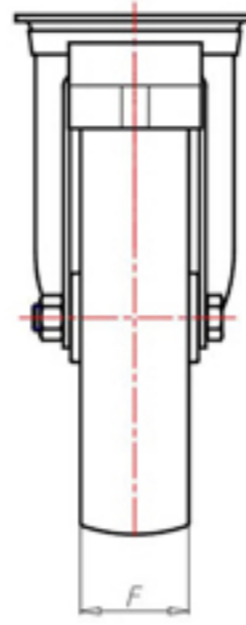
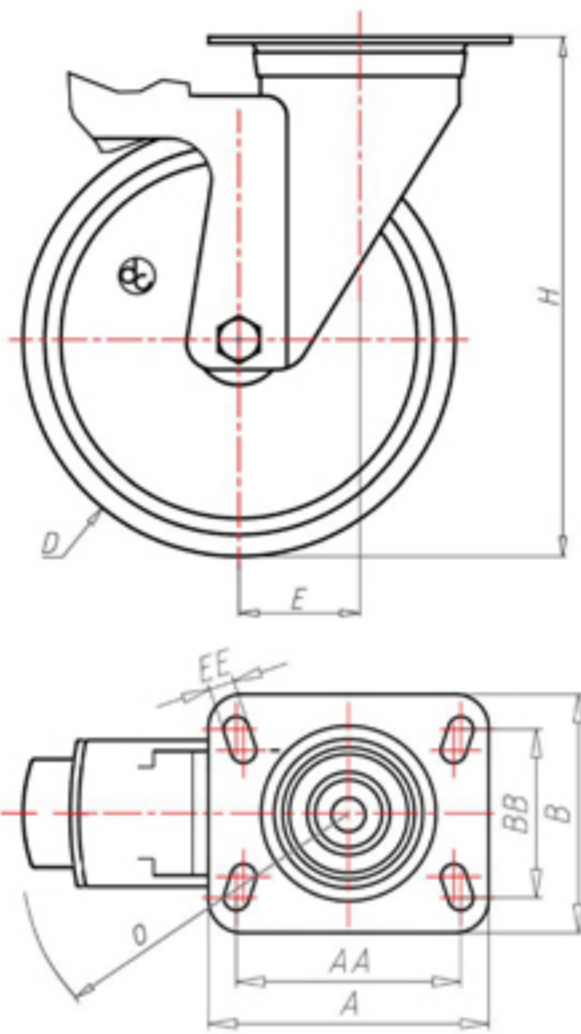

	D	150
	F	40
	H	155
	AxB	100x85
	AAxBB	80x60
	EE	9
	E	44
	O	124
	LC	230



Code for plain bore wheel

SGX12545FS



Code for wheel with coated bush

SGX12545BRFS



Code for wheel with double BT self-lube bush

-



Code for wheel with double HT ball bearing

-

