

**DITHERM
STW**

+280°C
-70°C

INOX

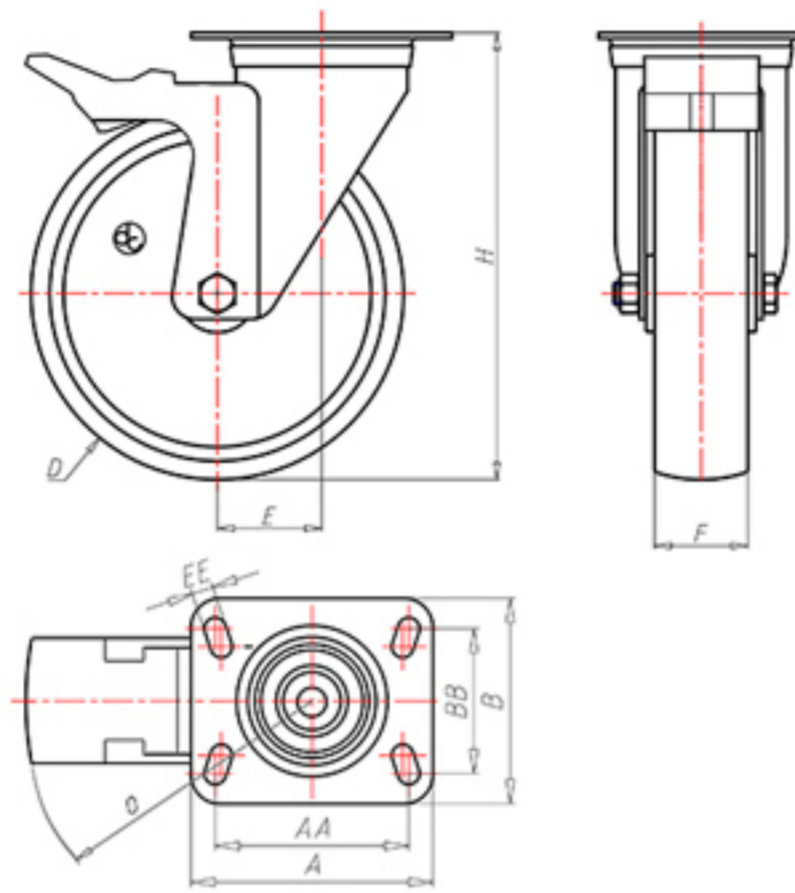

	D	150
	F	40
	H	181
	AxB	100x85
	AAxBB	80x60
	EE	9
	E	46
	O	124
	LC	250



Code for plain bore wheel

SGX15045PFA



Code for wheel with coated bush

-



Code for wheel with double BT self-lube bush

-



Code for wheel with double HT ball bearing

-

