

D-NAMIC

92 Shore A
+90°C
-40°C

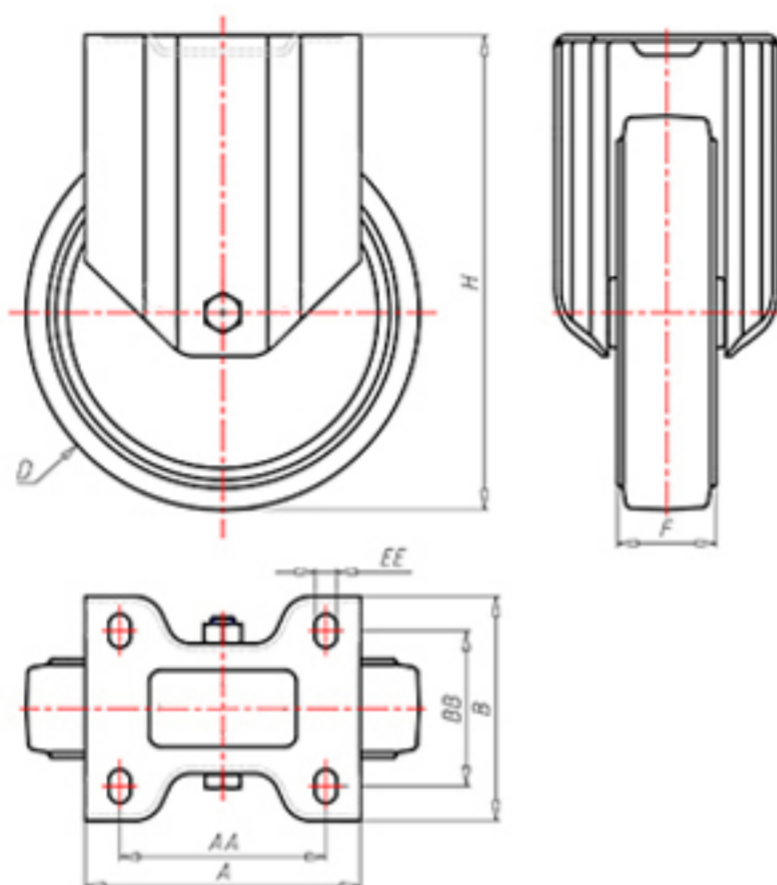

	D	150
	F	40
	H	181
	AxB	100x85
	AAxBB	80x60
	EE	9
	LC	280



Code for plain bore wheel

XNFZ15045



Code for wheel with roller bearing

XNFZ15045R



Code for wheel with double sealed ball bearing

XNFZ150C



Code for wheel with double sealed Inox ball bearing

-

