

D-NAMIC

92 Shore A
+90°C
-40°C

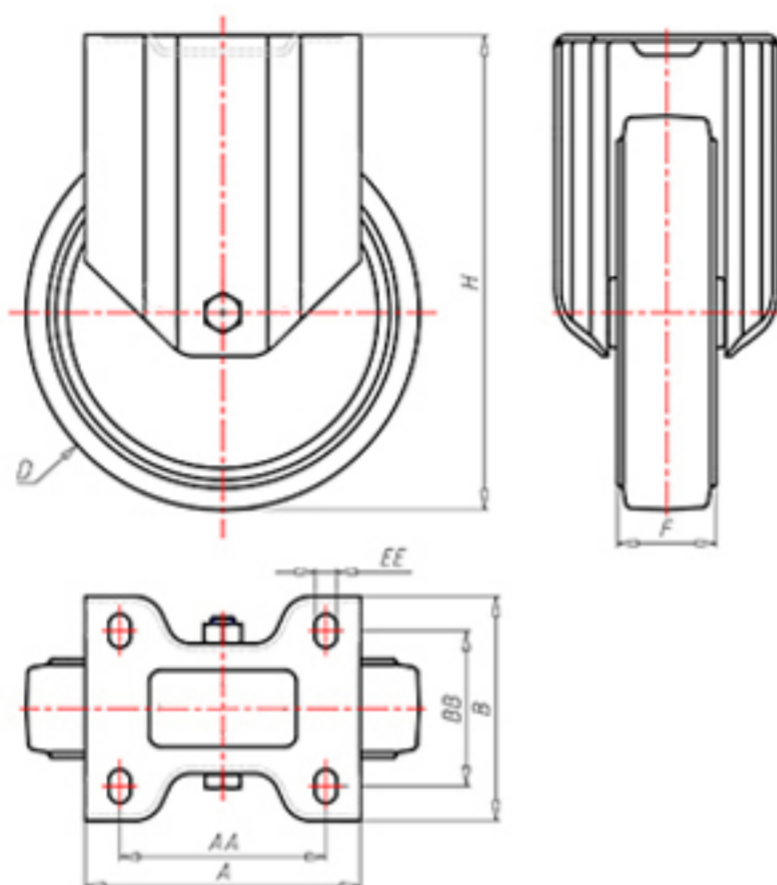

	D	80
	F	33
	H	108
	AxB	100x85
	AAxBB	80x60
	EE	9
	LC	210



Code for plain bore wheel

XNFZ8040

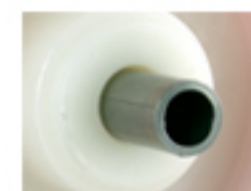

Code for wheel with roller bearing

XNFZ8040R



Code for wheel with double sealed ball bearing

XNFZ8040C



Code for wheel with double sealed Inox ball bearing

-

