

D-NAMIC

92 Shore A  
+90°C  
-40°C

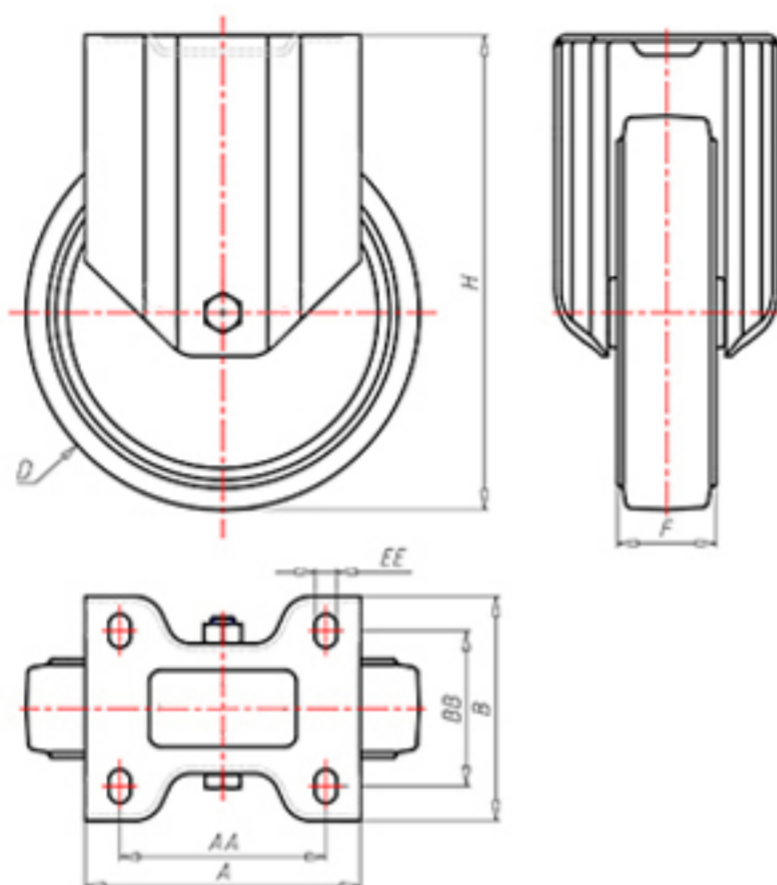

	D	80
	F	33
	H	108
	AxB	100x85
	AAxBB	80x60
	EE	9
	LC	210



Code for plain bore wheel

XNFZ8045



Code for wheel with roller bearing

XNFZ8045R



Code for wheel with double sealed ball bearing

XNFZ80C



Code for wheel with double sealed Inox ball bearing

-

