

D-NAMIC

92 Shore A
+90°C
-40°C

INOX

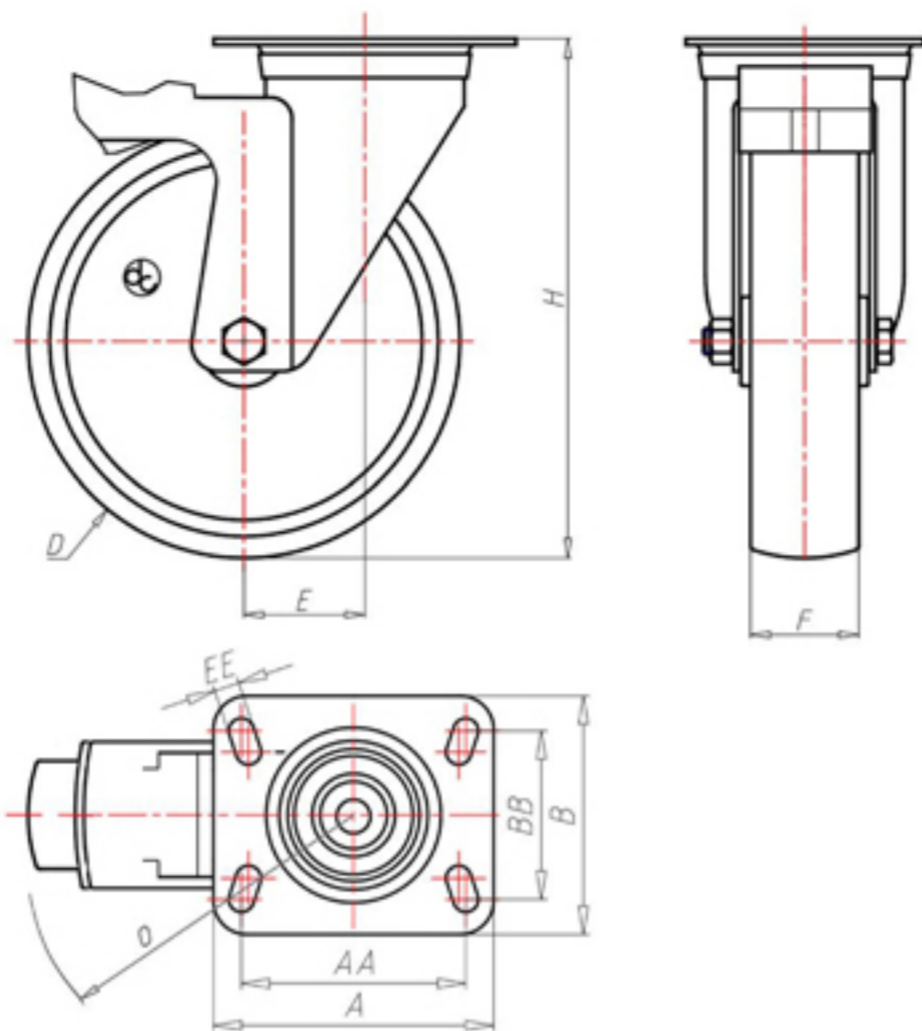

	D	100
	F	33
	H	128
	AxB	100x85
	AAxBB	80x60
	EE	9
	E	42
	O	124
	LC	220



Code for plain bore wheel

XNGX10045FS



Code for wheel with Inox roller bearing

XNGX10045RXFS



Code for wheel with double sealed ball bearing

XNGX100CFS



Code for wheel with double sealed Inox ball bearing

XNGX100CXFS

