

D-NAMIC

92 Shore A
+90°C
-40°C

INOX

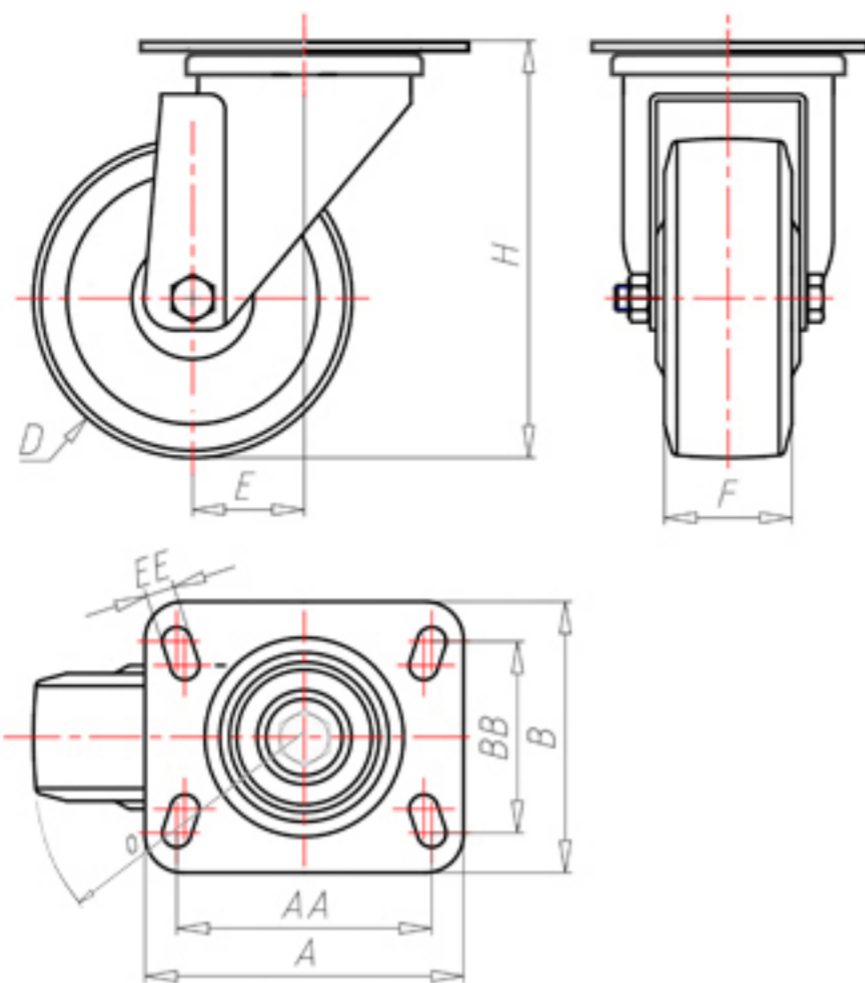

	D	150
	F	40
	H	184
	AxB	100x85
	AAxBB	80x60
	EE	9
	E	46
	O	107
	LC	280



Code for plain bore wheel

XNGX15045P



Code for wheel with Inox roller bearing

XNGX15045PRX



Code for wheel with double sealed ball bearing

XNGX15045PC



Code for wheel with double sealed Inox ball bearing

XNGX15045PCX

