

D-NAMIC

92 Shore A
+90°C
-40°C

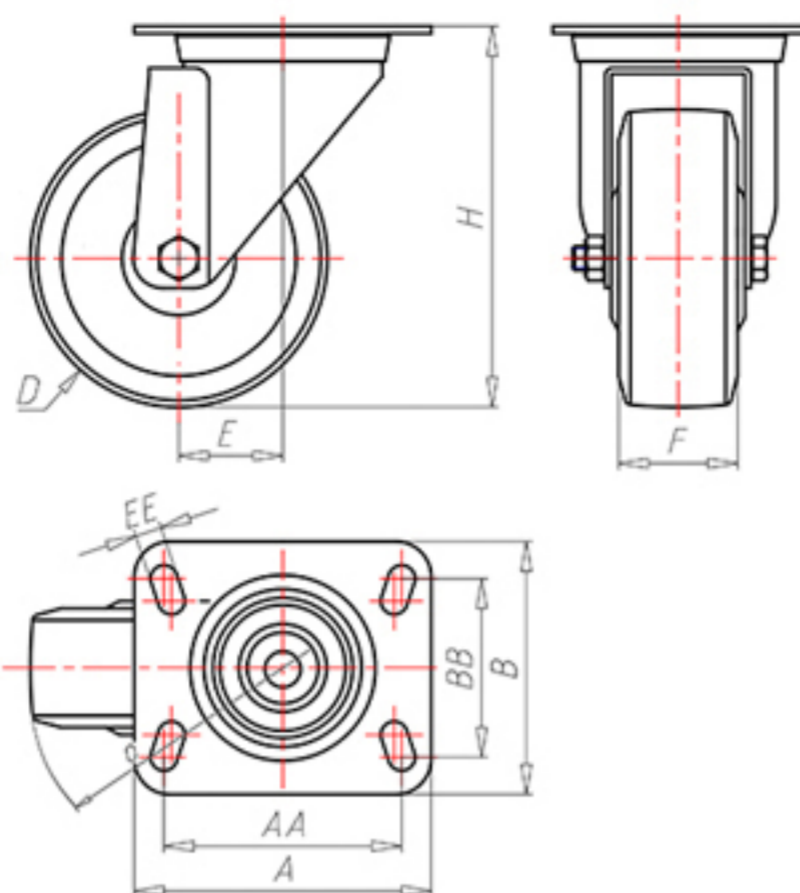

	D	100
	F	33
	H	128
	AxB	100x85
	AAxBB	80x60
	EE	9
	E	42
	O	92
	LC	220



Code for plain bore wheel

XNGZ10040



Code for wheel with roller bearing

XNGZ10040R



Code for wheel with double sealed ball bearing

XNGZ10040C



Code for wheel with double sealed Inox ball bearing

-

