

D-NAMIC

92 Shore A
+90°C
-40°C

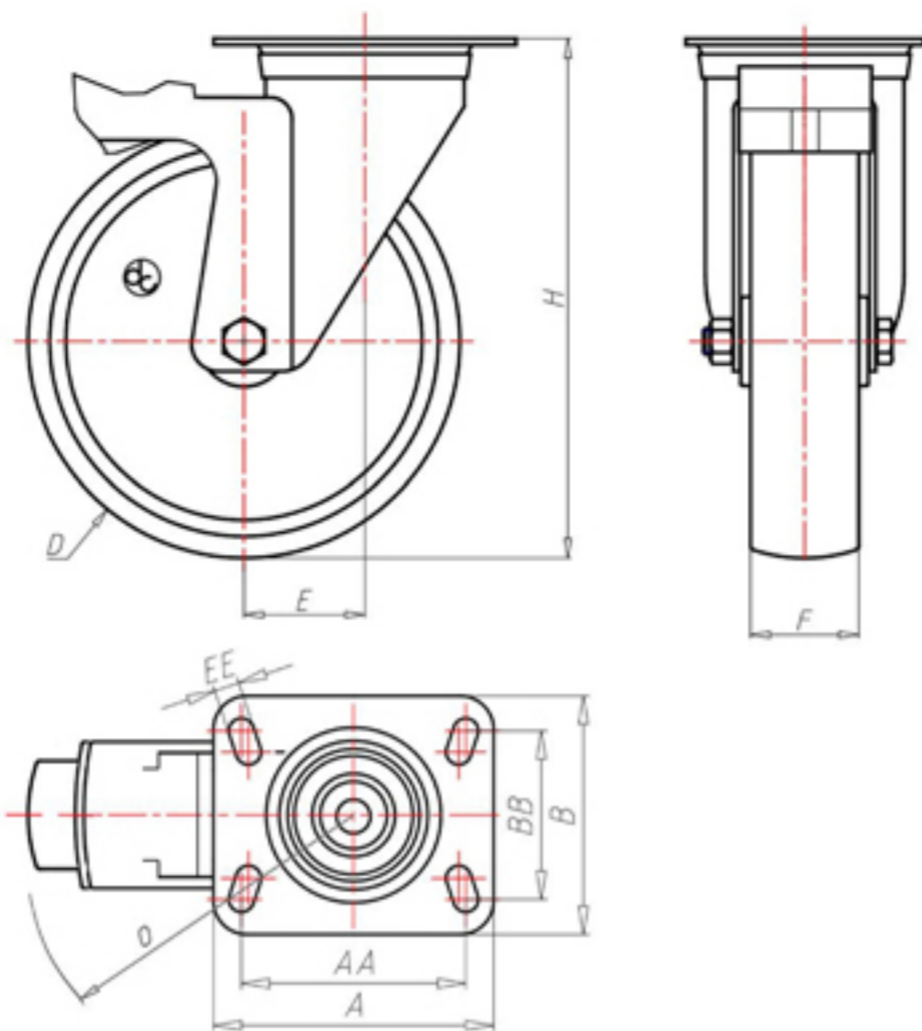

	D	125
	F	35
	H	155
	AxB	100x85
	AAxBB	80x60
	EE	9
	E	44
	O	124
	LC	230



Code for plain bore wheel

XNGZ12545FS



Code for wheel with roller bearing

XNGZ12545RFS



Code for wheel with double sealed ball bearing

XNGZ125CFS



Code for wheel with double sealed Inox ball bearing

-

