

D-NAMIC

92 Shore A  
+90°C  
-40°C

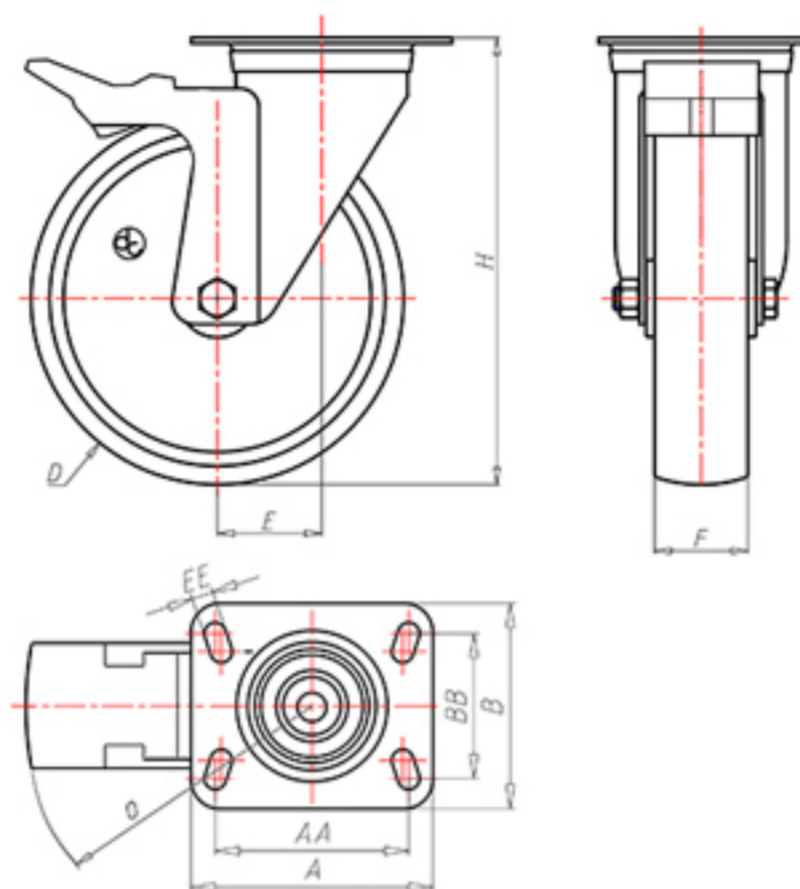

	D	150
	F	40
	H	181
	AxB	135x110
	AAxBB	105x80
	EE	11
	E	52
	O	124
	LC	350



Code for plain bore wheel

XNGZ15060FA



Code for wheel with roller bearing

XNGZ15060RFA



Code for wheel with double sealed ball bearing

XNGZ15060CFA



Code for wheel with double sealed Inox ball bearing

-

