

D-NAMIC

92 Shore A
+90°C
-40°C

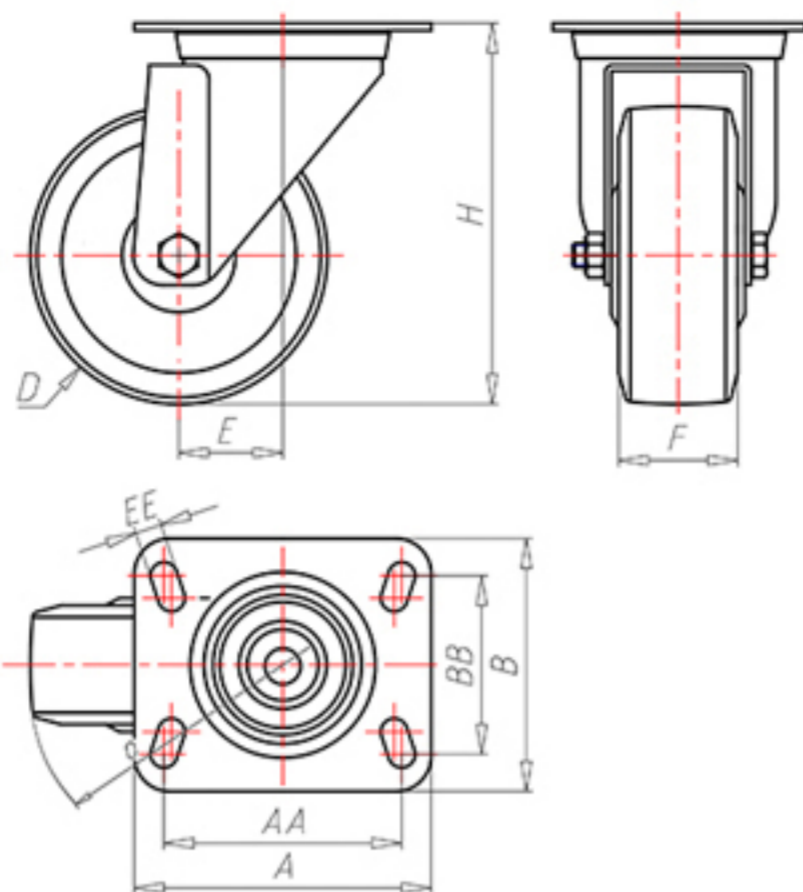

	D	200
	F	50
	H	232
	AxB	135x110
	AAxBB	105x80
	EE	11
	E	56
	O	167
	LC	400



Code for plain bore wheel

XNGZ20060



Code for wheel with roller bearing

XNGZ20060R



Code for wheel with double sealed ball bearing

XNGZ200C



Code for wheel with double sealed Inox ball bearing

-

