

D-NAMIC

92 Shore A
+90°C
-40°C

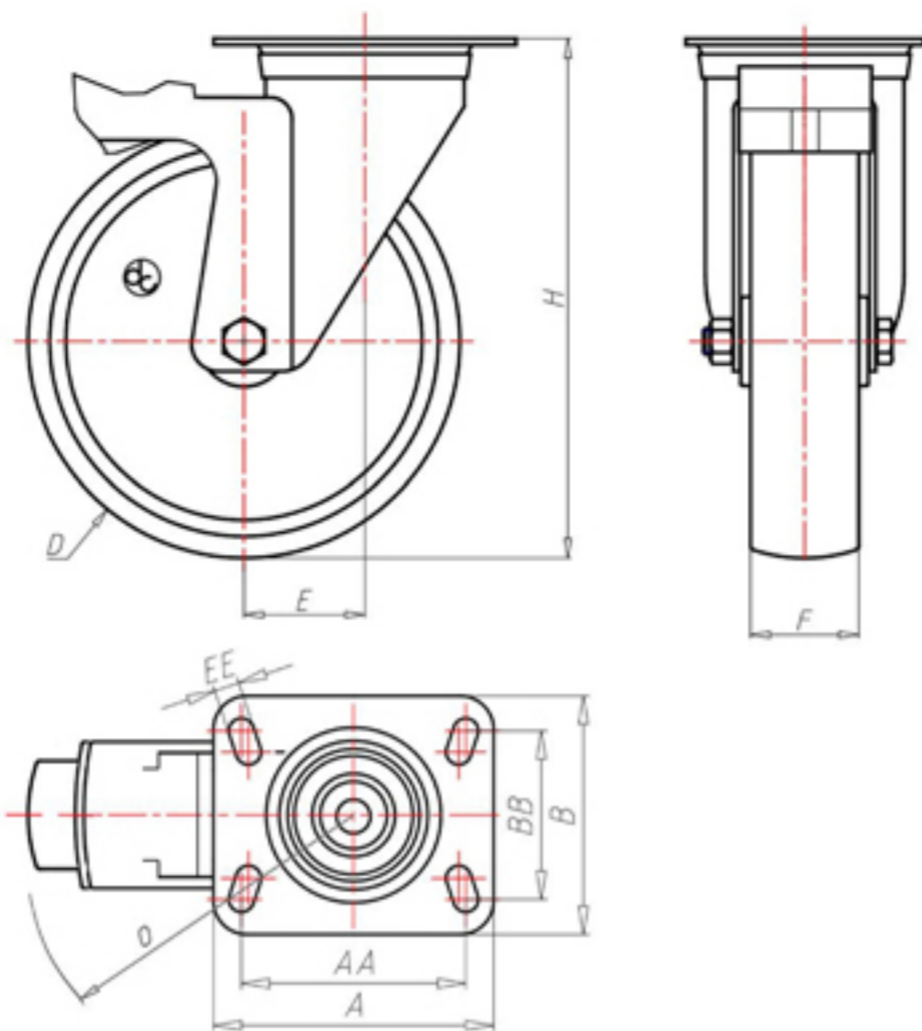

	D	80
	F	33
	H	108
	AxB	100x85
	AAxBB	80x60
	EE	9
	E	40
	O	124
	LC	200



Code for plain bore wheel

XNGZ8045FS



Code for wheel with roller bearing

XNGZ8045RFS



Code for wheel with double sealed ball bearing

XNGZ80CFS



Code for wheel with double sealed Inox ball bearing

-

