

D-NAMIC

92 Shore A
+90°C
-40°C

INOX

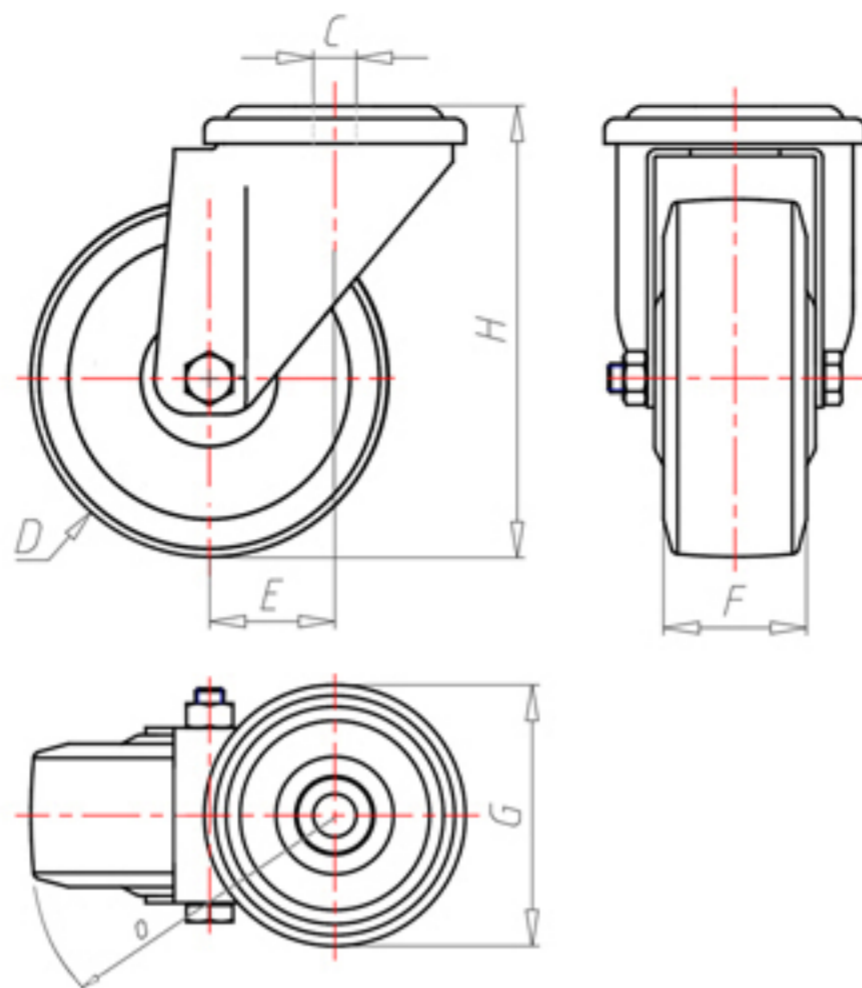

	D	150
	F	40
	H	181
	G	Ø 77
	C	Ø 12
	E	46
	O	124
	LC	250



Code for plain bore wheel

XNPX15045



Code for wheel with Inox roller bearing

XNPX15045RX



Code for wheel with double sealed ball bearing

XNPX15045C



Code for wheel with double sealed Inox ball bearing

XNPX15045CX

