

D-NAMIC

92 Shore A
+90°C
-40°C

INOX

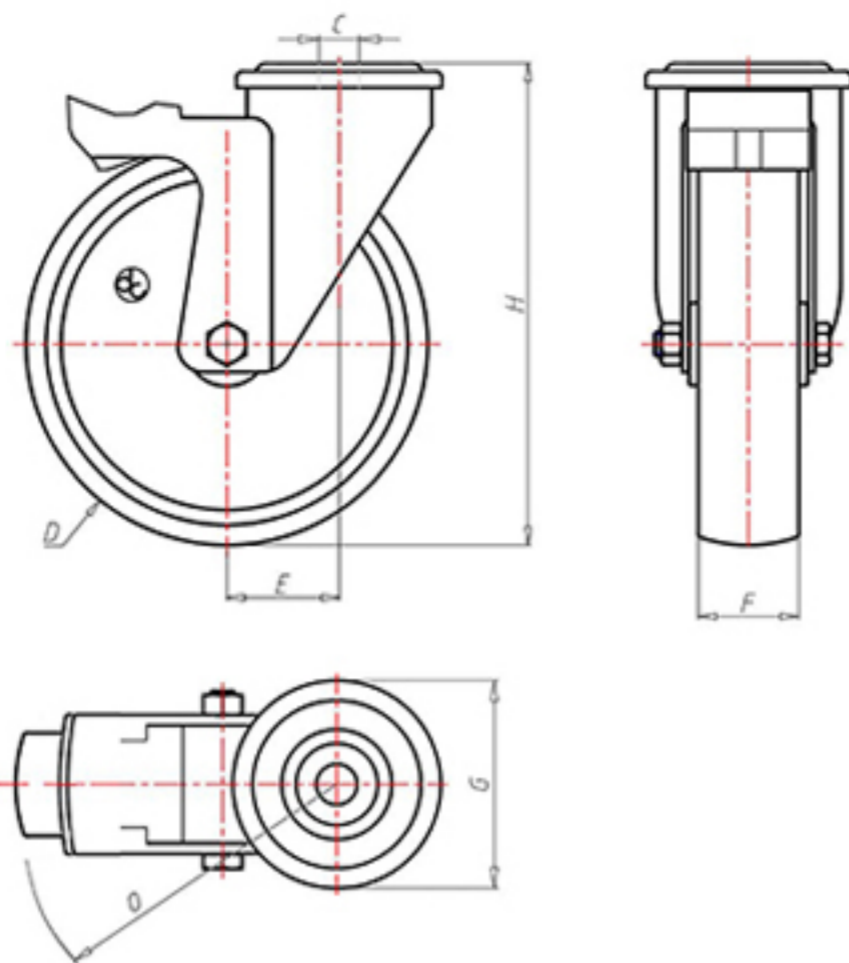

	D	80
	F	33
	H	108
	G	Ø 77
	C	Ø 12
	E	40
	O	124
	LC	200



Code for plain bore wheel

XNPX8040FS



Code for wheel with Inox roller bearing

XNPX8040RXFS



Code for wheel with double sealed ball bearing

XNPX8040CFS



Code for wheel with double sealed Inox ball bearing

XNPX8040CXFS

