

D-NAMIC

92 Shore A
+90°C
-40°C

INOX

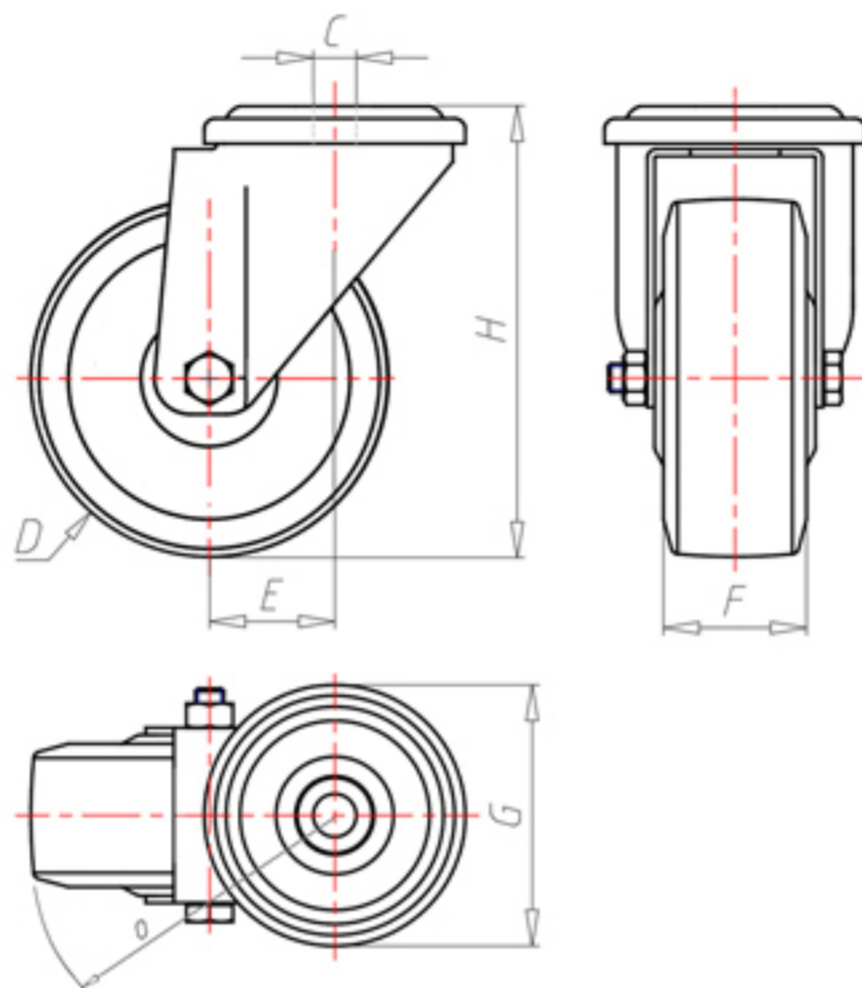

	D	80
	F	33
	H	108
	G	Ø 77
	C	Ø 12
	E	40
	O	82
	LC	200



Code for plain bore wheel

XNPX8045



Code for wheel with Inox roller bearing

XNPX8045RX



Code for wheel with double sealed ball bearing

XNPX80C



Code for wheel with double sealed Inox ball bearing

XNPX80CX

