

D-NAMIC

92 Shore A
+90°C
-40°C

INOX

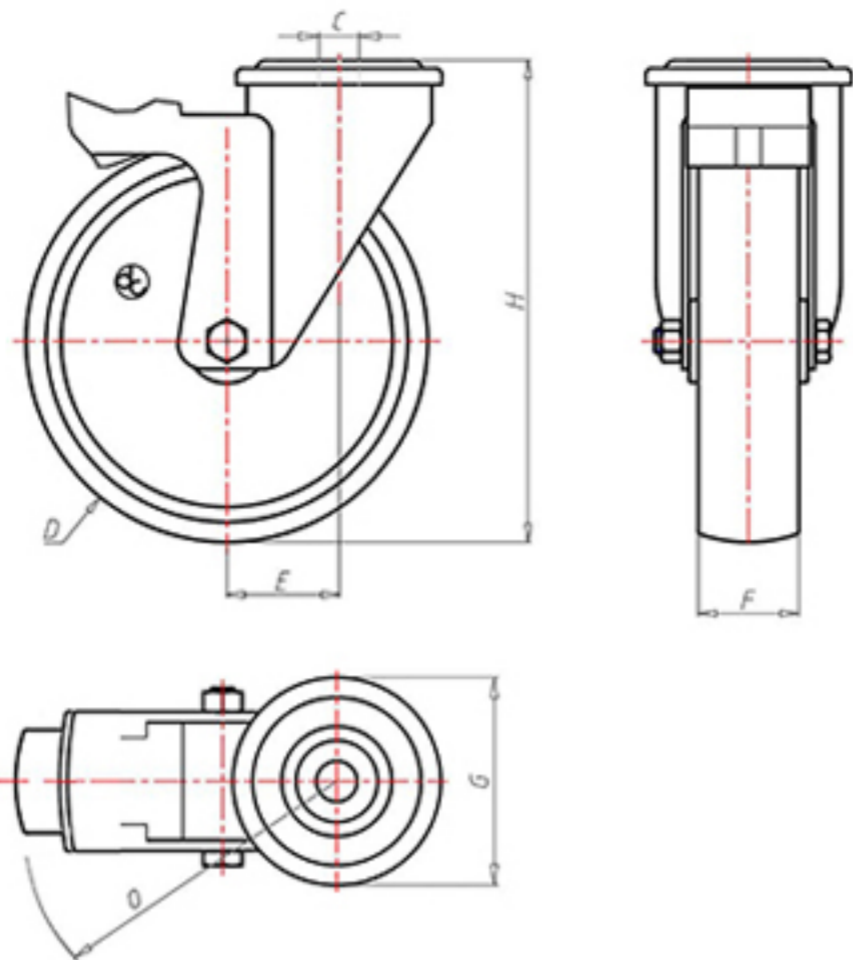

	D	80
	F	33
	H	108
	G	Ø 77
	C	Ø 12
	E	40
	O	124
	LC	200



Code for plain bore wheel

XNPX8045FS



Code for wheel with Inox roller bearing

XNPX8045RXFS



Code for wheel with double sealed ball bearing

XNPX80CFS



Code for wheel with double sealed Inox ball bearing

XNPX80CXFS

