

D-NAMIC

92 Shore A
+90°C
-40°C

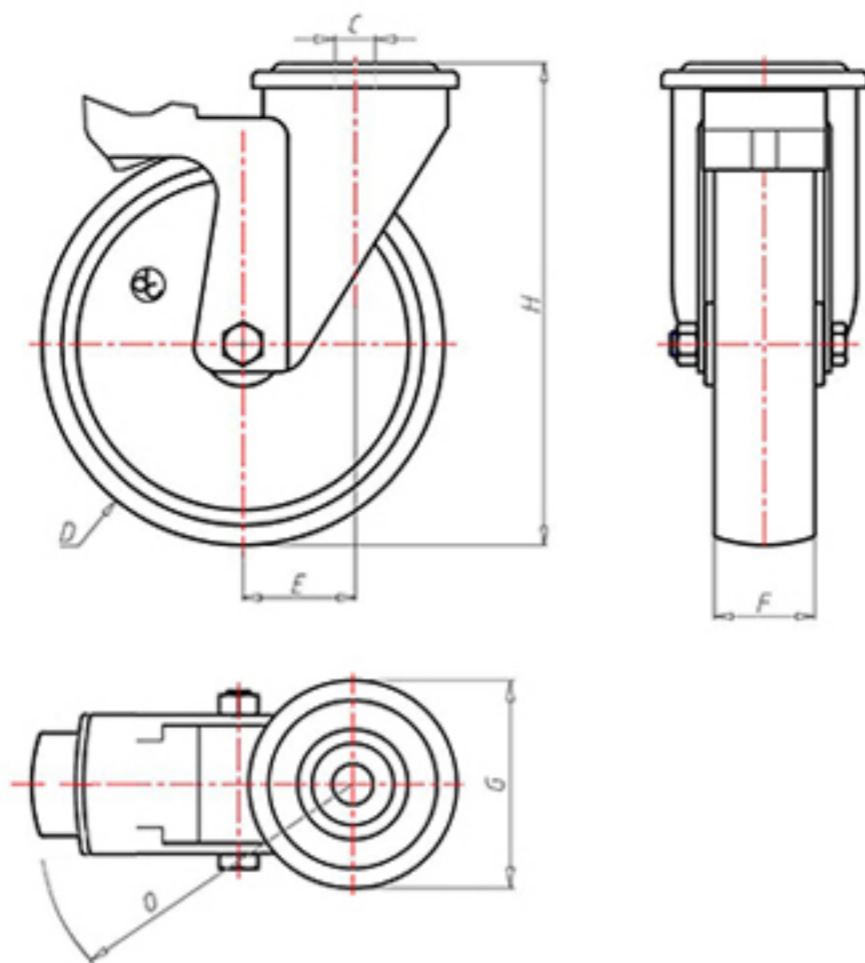

	D	100
	F	33
	H	128
	G	Ø 77
	C	Ø 12
	E	42
	O	124
	LC	220



Code for plain bore wheel

XNPZ10040FS



Code for wheel with roller bearing

XNPZ10040RFS



Code for wheel with double sealed ball bearing

XNPZ10040CFS



Code for wheel with double sealed Inox ball bearing

-

