

D-NAMIC

92 Shore A  
+90°C  
-40°C

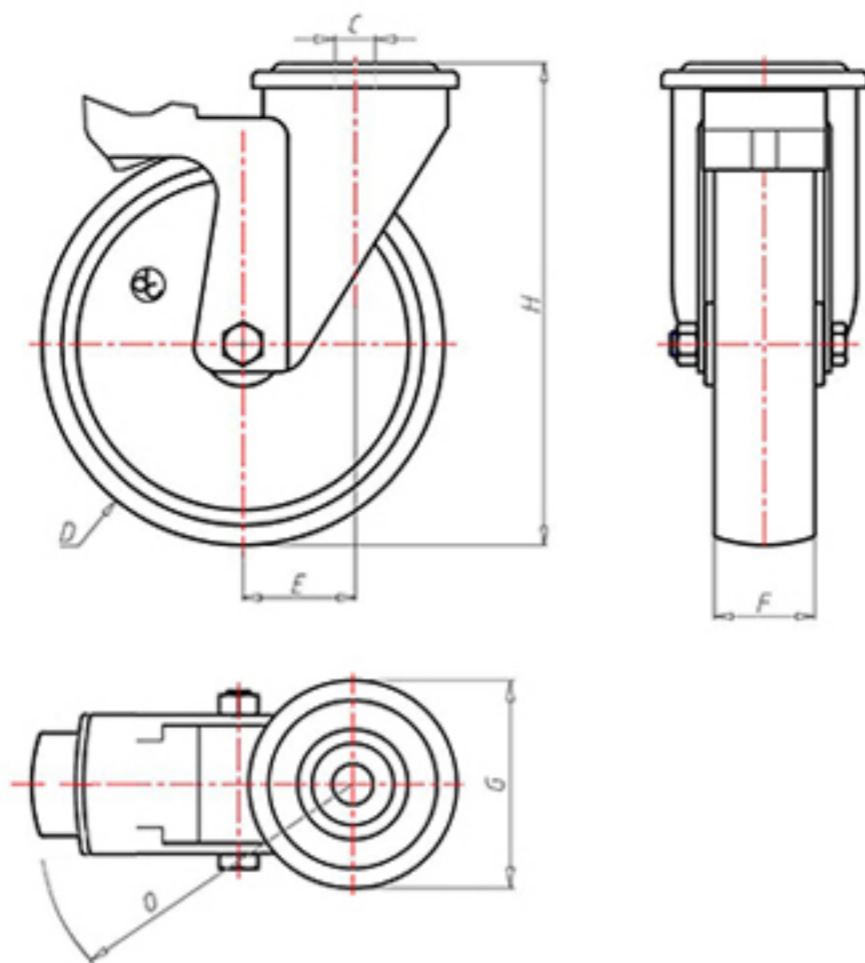

	D	80
	F	33
	H	108
	G	Ø 77
	C	Ø 12
	E	40
	O	124
	LC	200



Code for plain bore wheel

XNPZ8040FS



Code for wheel with roller bearing

XNPZ8040RFS



Code for wheel with double sealed ball bearing

XNPZ8040CFS



Code for wheel with double sealed Inox ball bearing

-

